

CODA

one-person acoustic booth

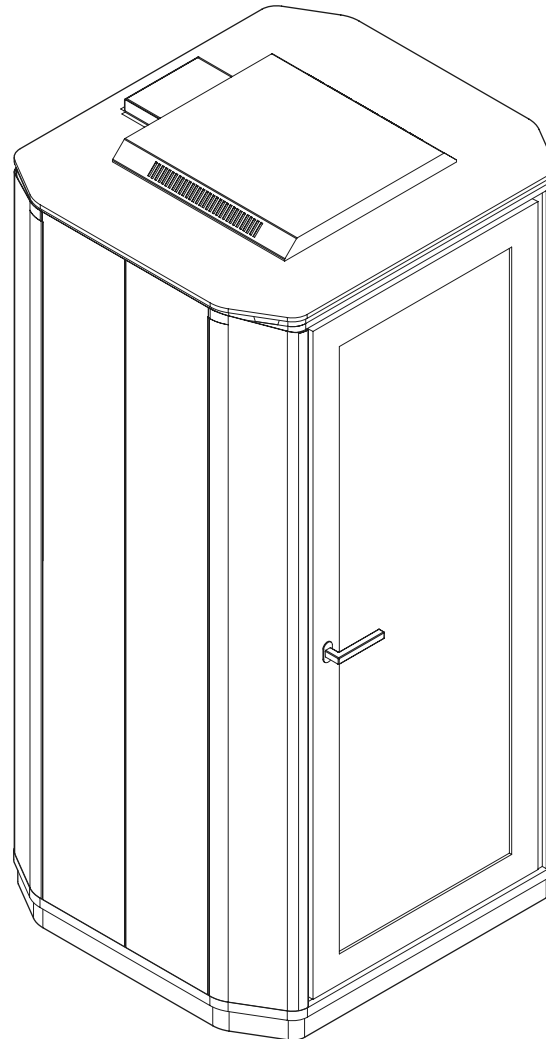

.mdd

disclaimers

Polski

UWAGA!

Przed rozpoczęciem montażu należy uważnie przeczytać instrukcję i postępować zgodnie z jej zaleceniami. Instrukcję zachować na przyszłość. Do montażu używać wyłącznie sprawnych i odpowiednich narzędzi. W przypadku pytań lub wątpliwości prosimy o kontakt.

Przed montażem sprawdzić zawartość paczek. Wszelkie uszkodzenia lub braki należy udokumentować i sfotografować przed rozpoczęciem montażu. W przypadku reklamacji należy dołączyć zdjęcie etykiety z opakowania.

Zeskanuj, aby zgłosić reklamację



Français

ATTENTION !

Lisez attentivement les instructions avant de commencer l'installation et suivez-les. Conservez ces instructions pour pouvoir vous y référer ultérieurement. N'utilisez que des outils efficaces et appropriés pour l'assemblage. Si vous avez des questions, n'hésitez pas à nous contacter.

Vérifiez le contenu des colis avant l'installation. Tout dommage ou manque doit être documenté et photographié avant l'installation. En cas de réclamation, veuillez joindre une photo de l'étiquette de l'emballage.

Numérisez pour déposer une plainte



English

WARNING!

Read the instruction manual before starting the assembly and follow them carefully. Keep the manual for future reference. Use only efficient and suitable tools. Contact us, if you have any questions or concerns.

Check the contents of the packages before assembly. Any damage or shortages must be documented and photographed before assembly. In case of a claim, attach a photo of the package label.

Scan to file a complaint



Español

ATENCIÓN!

Lea atentamente las instrucciones antes de iniciar la instalación y siga las indicaciones. Conserve estas instrucciones para futuras consultas. Utilice únicamente herramientas eficaces y adecuadas para el montaje. Si tiene alguna duda o consulta, póngase en contacto con nosotros.

Compruebe el contenido de los paquetes antes de la instalación. Cualquier daño o falta debe documentarse y fotografiarse antes de la instalación. En caso de reclamación, adjunte una foto de la etiqueta del paquete.

Escanee para presentar una queja/una queja



Deutsch

ACHTUNG!

Lesen Sie die Anleitung sorgfältig durch, bevor Sie mit der Installation beginnen, und befolgen Sie die Anweisungen. Bewahren Sie diese Anleitung zum späteren Nachschlagen auf. Verwenden Sie für die Montage nur effizientes und geeignetes Werkzeug. Bitte kontaktieren Sie uns, wenn Sie Fragen oder Bedenken haben.

Kontrollieren Sie den Inhalt der Pakete vor der Montage. Eventuelle Schäden oder Fehlmengen müssen vor dem Einbau dokumentiert und fotografiert werden. Im Falle einer Reklamation fügen Sie bitte ein Foto des Verpackungsetiketts bei.

Scannen, um eine Beschwerde einzureichen



Italiano

ATTENZIONE !

Leggere attentamente le istruzioni prima di iniziare l'installazione e seguirle. Conservare queste istruzioni per riferimenti futuri. Per il montaggio, utilizzare solo strumenti efficienti e adatti. Se avete domande o dubbi, contattateci.

Controllare il contenuto delle confezioni prima dell'installazione. Eventuali danni o mancanze devono essere documentati e fotografati prima dell'installazione. In caso di reclamo, allegare una foto dell'etichetta della confezione.

Scansiona per presentare un reclamo



valid for

CD01

CD01Q

components

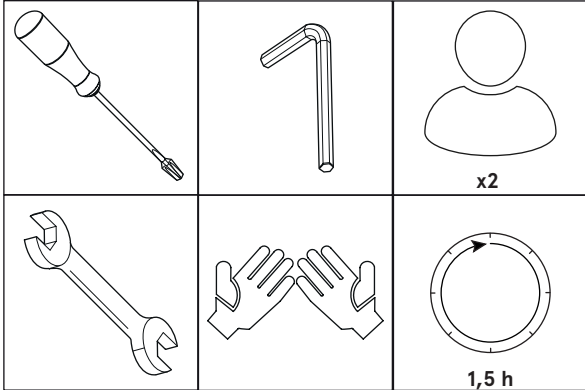

A

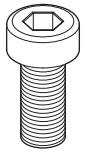

M6X14
x63

B

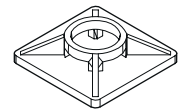

x10

C

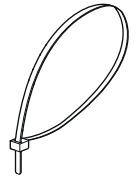

x10

D

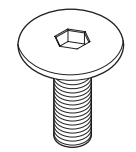

M6X25B WWI
x12

E

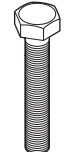

M6X20 S6K
x16

F

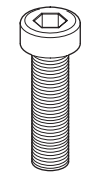

M6X40
x8

G

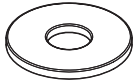

8X24X2
x8

H



M6X65 WWI
x7

I



M6X55WWI
X12

J

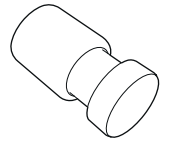

x1

K

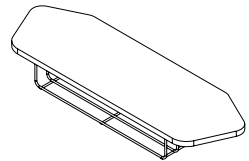

x1

L

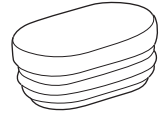

x1

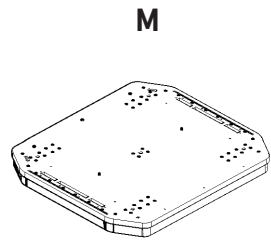

x1

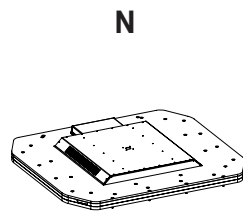

x1

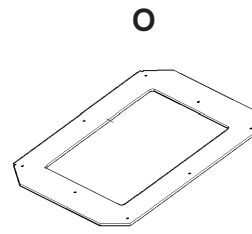

x1

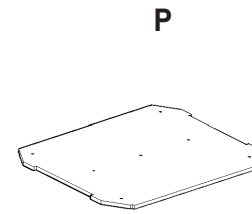

x1

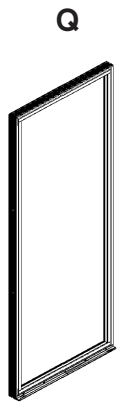

x1

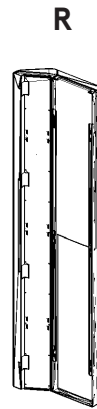

x1

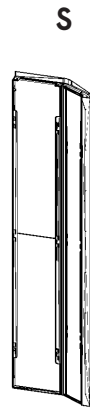

x1



x1

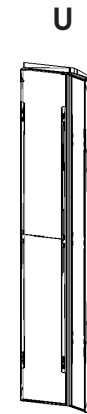

x1

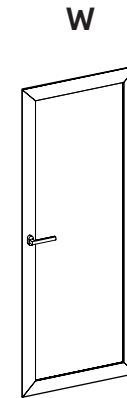

x1



x1

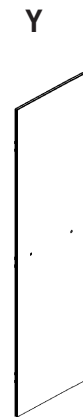

x1



x1



x1



x1



x1

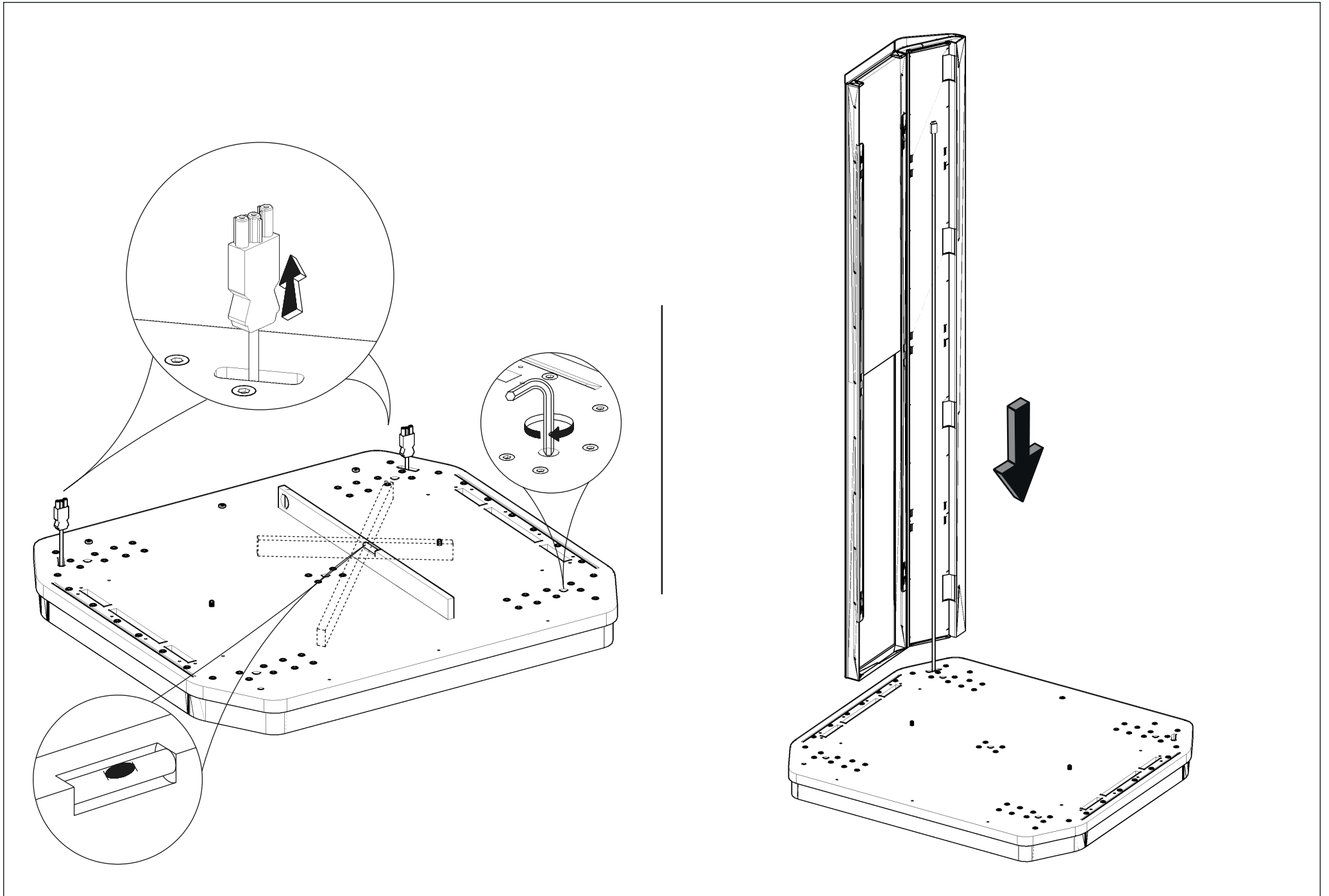

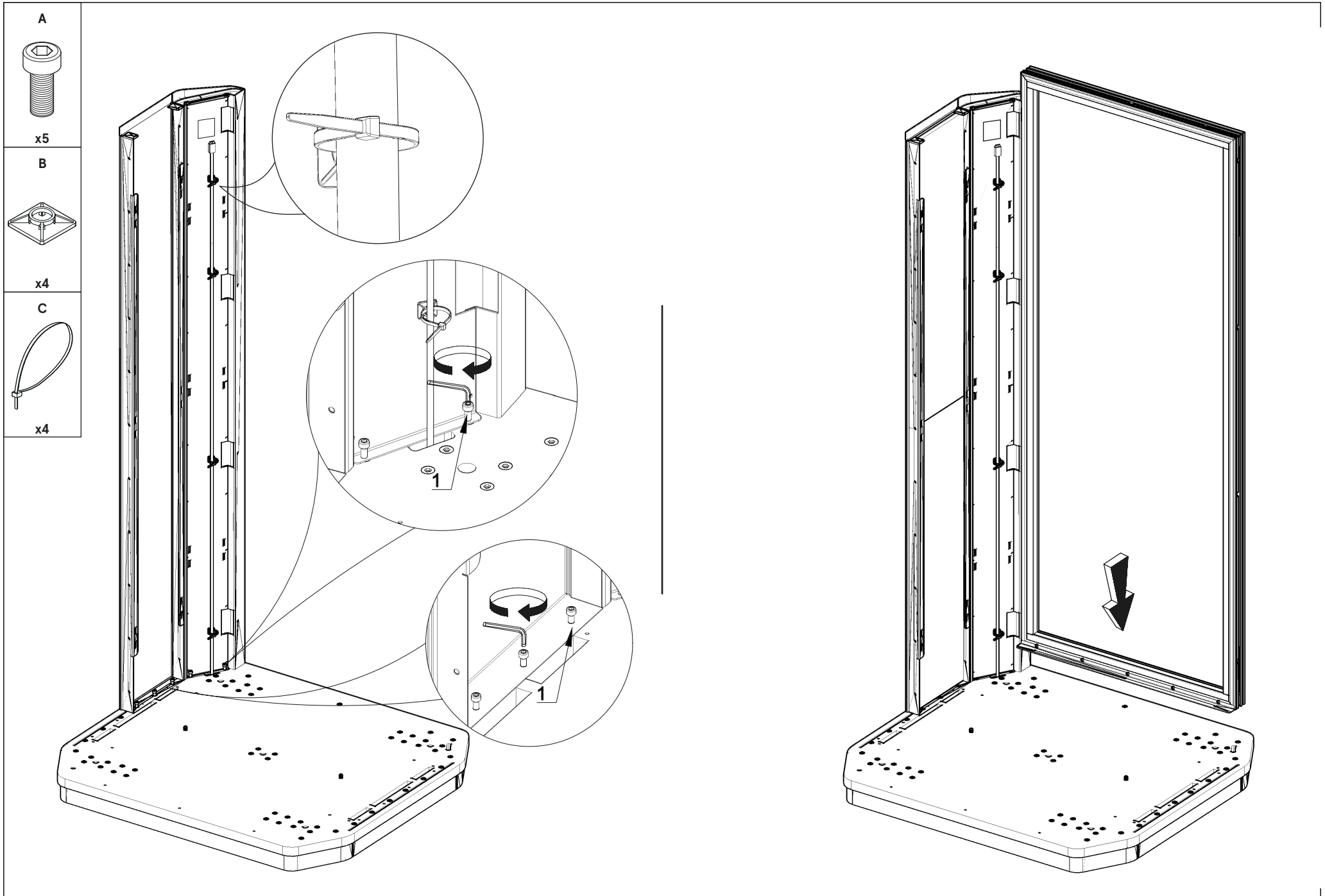

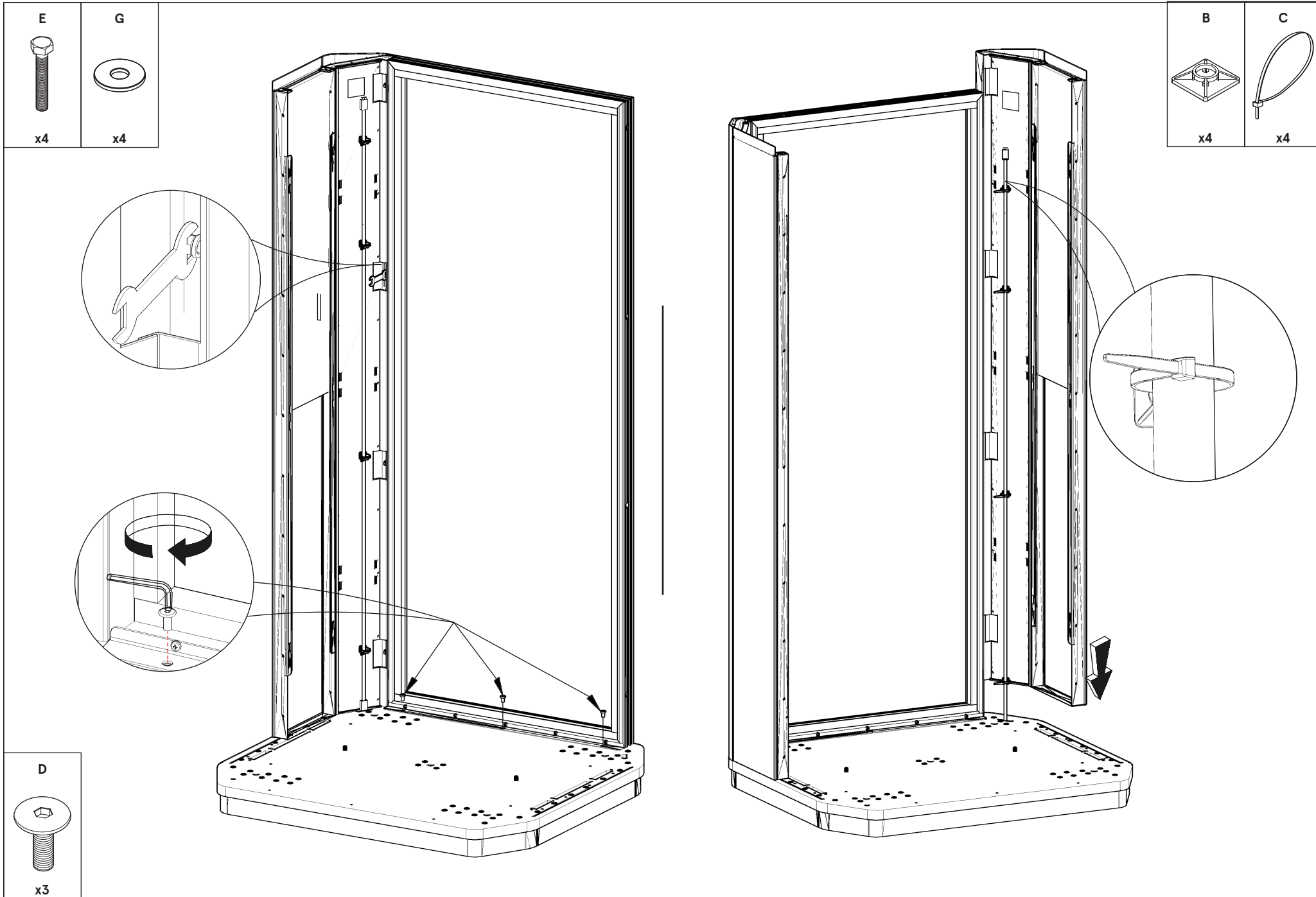

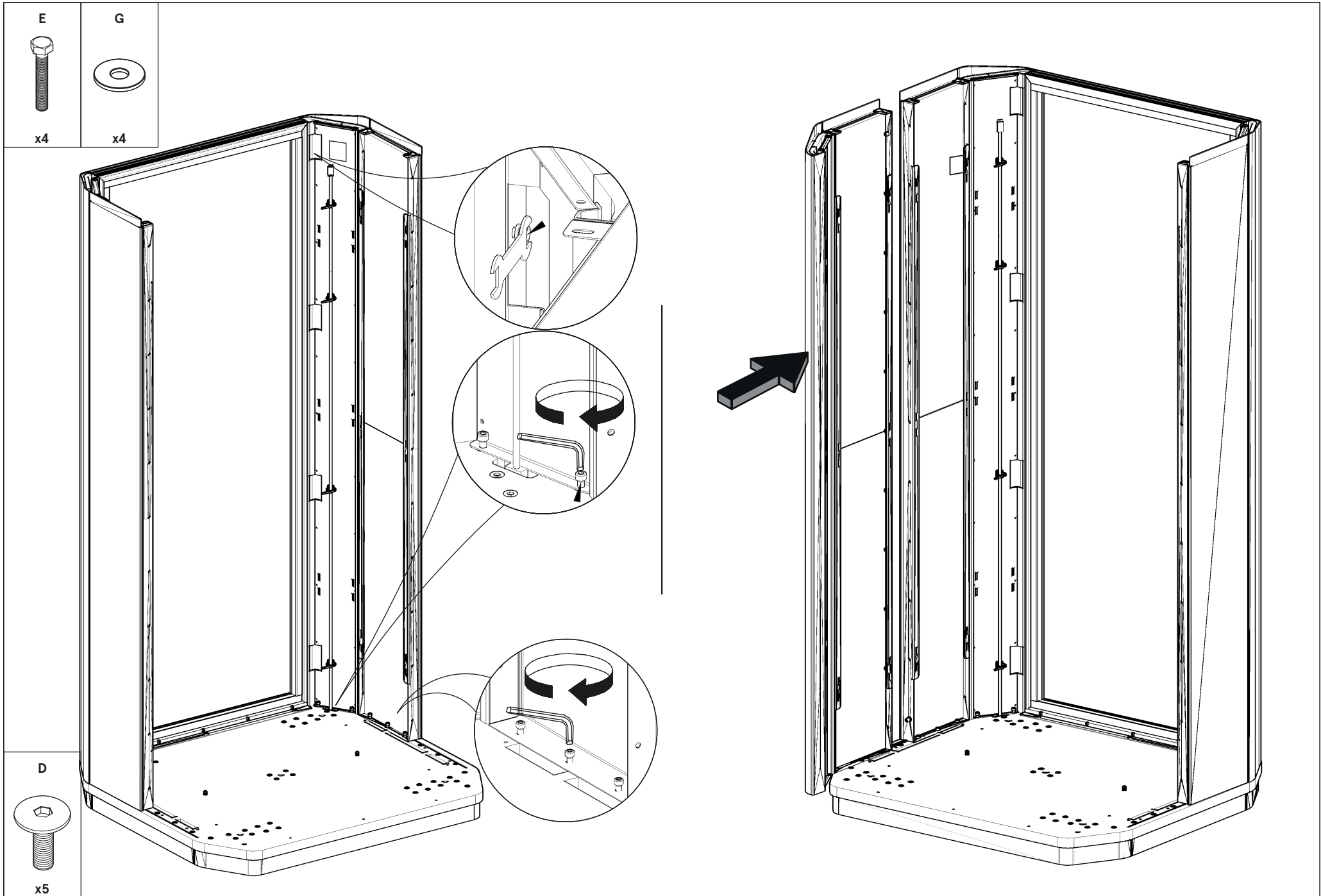

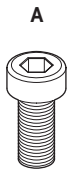

x16

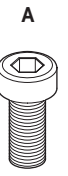
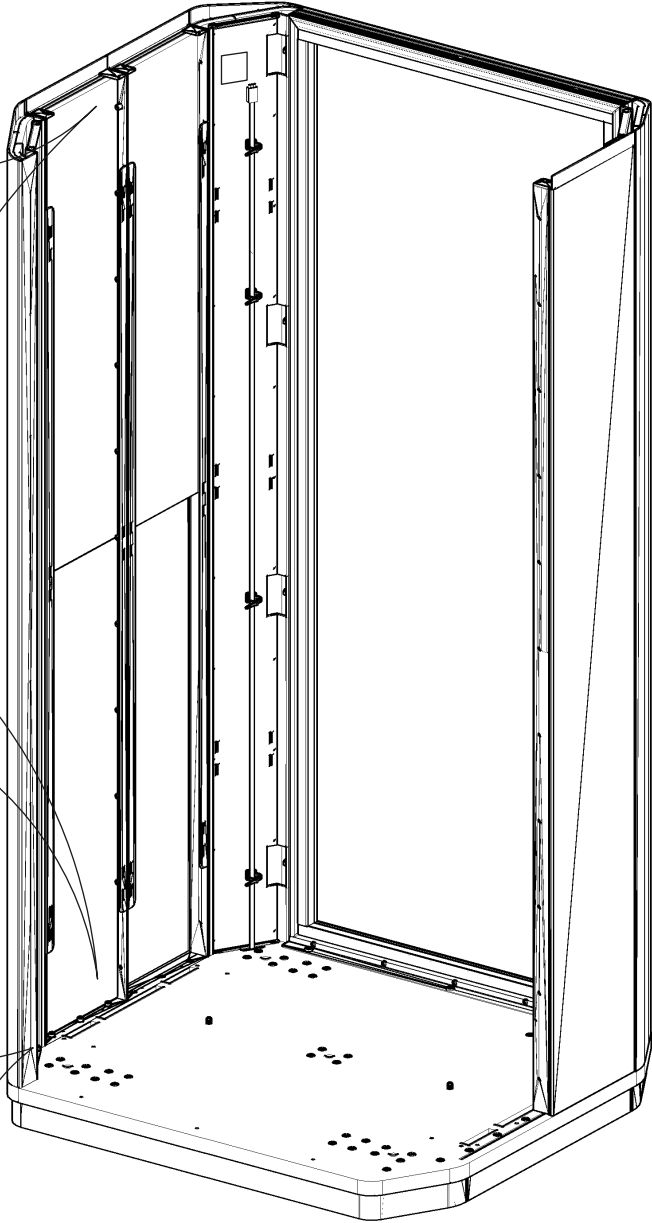
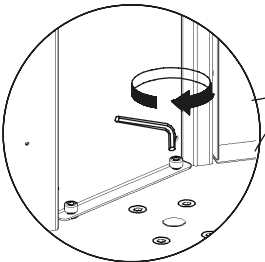
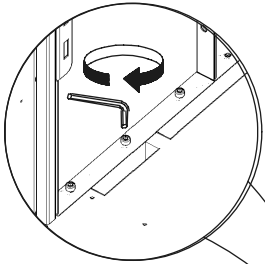
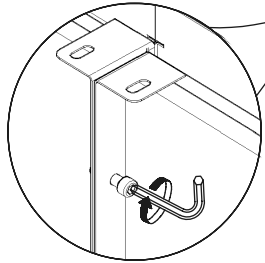

x16

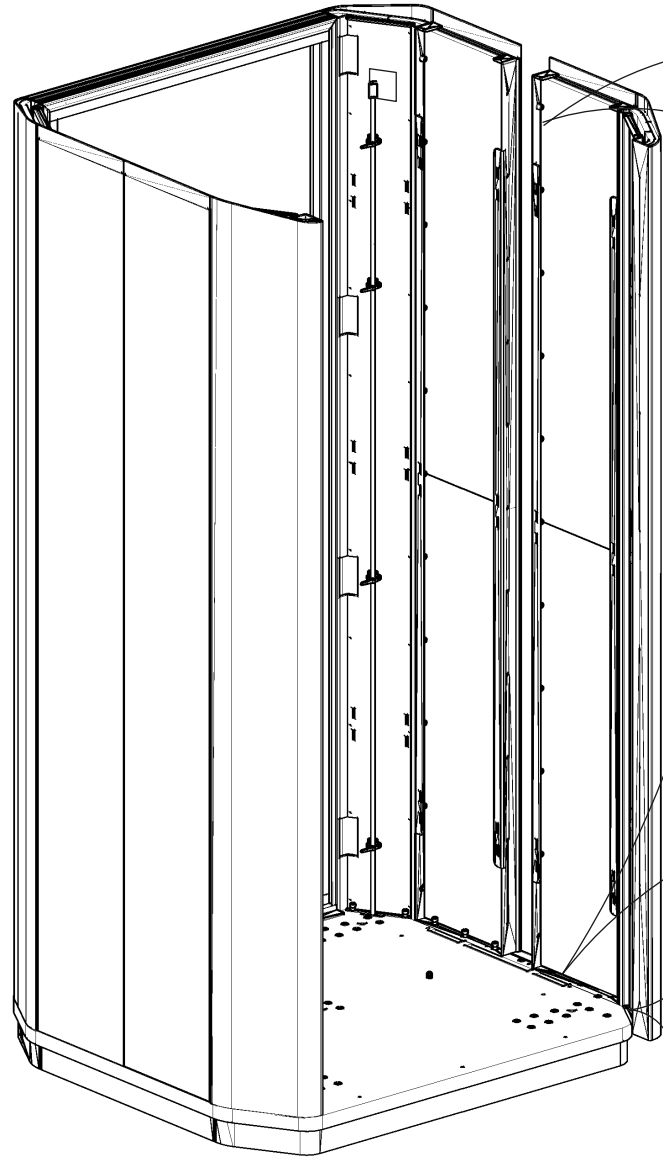
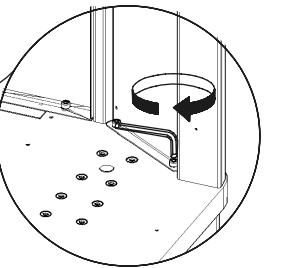
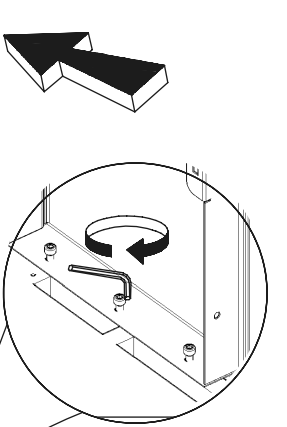
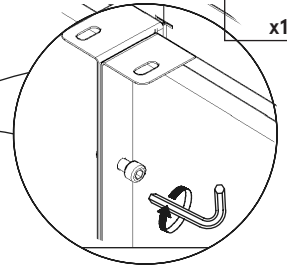

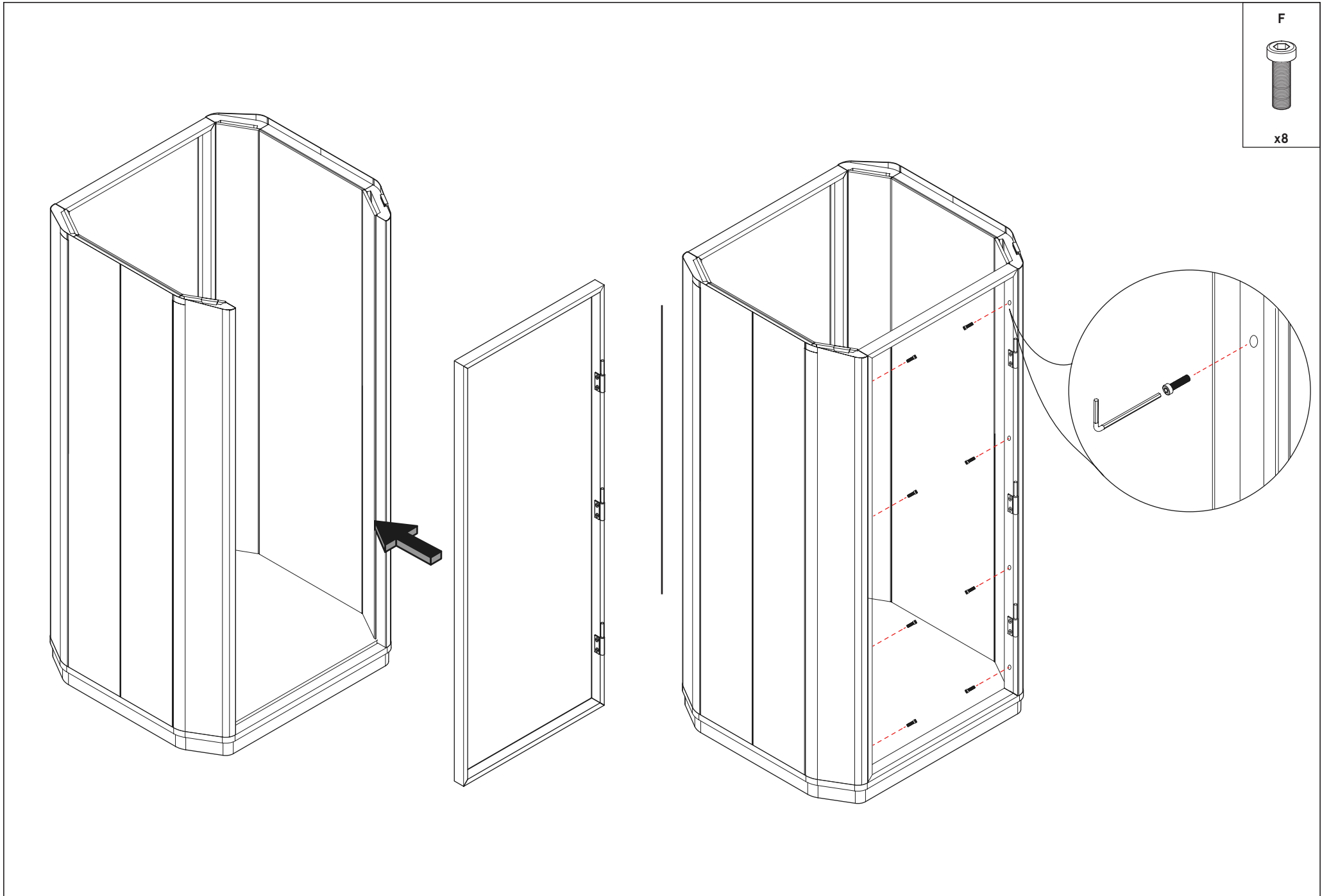

F

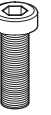

x8

